



**KANDİLLİ OBSERVATORY and EARTHQUAKE
RESEARCH INSTITUTE**



***March 08, 2010 BAŞYURT-KARAKOÇAN
(ELAZIĞ) EARTHQUAKE***



**Prepared by; Dr. Doğan Kalafat
Dr. Can Zülfikar
Res. Assist. Eren Vuran
Res. Assist. Yaver Kamer**

**March, 2010
İSTANBUL**

Contents

| | |
|--|----|
| Contents | 2 |
| List of Figures..... | 3 |
| List of Tables..... | 7 |
| 1 Introduction..... | 8 |
| 2 Regional Geology..... | 11 |
| 3 Seismo-tectonic Characteristics of the Region..... | 12 |
| 4 Earthquake Source Parameters..... | 13 |
| 5 Statistical Characteristics of the Earthquake..... | 14 |
| 6 Real-time Earthquake Shaking and Damage Estimations..... | 16 |
| 7 Strong Motion Records..... | 20 |
| 8 Building Types..... | 22 |
| 8.1 Masonry Houses with Sun-dried Soil Bricks..... | 22 |
| 8.2 Masonry Houses with Stones..... | 26 |
| 8.3 Masonry Houses with Infill Bricks..... | 33 |
| 8.4 Masonry Houses with Refractory Bricks..... | 39 |
| 8.5 Reinforced Concrete Houses..... | 46 |
| 9 Building Damage Types..... | 51 |
| 10 Results and Recommendations..... | 64 |

List of Figures

| | |
|---|----|
| Figure 1: <i>Area of which the earthquake became more effective</i> | 9 |
| Figure 2: <i>Distribution of aftershocks</i> | 11 |
| Figure 3: <i>Geology map of the region</i> | 11 |
| Figure 4: <i>The location of the March 08 2010 earthquake epicenter on active fault map (Saroglu et.al., 1992, MTA)</i> | 12 |
| Figure 5: <i>The distribution of the major earthquakes in the region (1900-2009; $M \geq 6.0$)</i> | 13 |
| Figure 6: <i>Faulting mechanism</i> | 13 |
| Figure 7: <i>Distribution of aftershocks and depths of aftershocks</i> | 14 |
| Figure 8: <i>Number of Earthquakes vs Magnitude and Number of Earthquakes vs Depth Histograms</i> | 14 |
| Figure 9: <i>Number of Earthquakes vs. Time and Number of Earthquakes vs. Hour Histograms</i> | 15 |
| Figure 10: <i>Cumulative Number of Earthquakes vs. Time and Cumulative Moment vs. Time</i> . | 15 |
| Figure 11: <i>Probable Intensity Map</i> | 16 |
| Figure 12: <i>Probable peak acceleration map</i> | 17 |
| Figure 13: <i>Modified Intensity Map</i> | 17 |
| Figure 14: <i>The resulting casualties calculated immediately after the main shock</i> | 19 |
| Figure 15: <i>Location of National Strong Motion Stations and acceleration-time waveforms</i> .. | 20 |
| Figure 16: <i>PGA-Distance relation obtained from National Strong Ground Motion Network and obtained attenuation relation equation</i> | 21 |
| Figure 17: <i>Approximate sun-dried soil brick dimensions</i> | 22 |
| Figure 18: <i>One storey soil brick house in Incedal village-side view 1 (bottom part of the house, below window level is built with stones)</i> | 22 |
| Figure 19: <i>One storey soil brick house in Incedal village-side view 2 (bottom part of the house, below window level is built with stones)</i> | 23 |
| Figure 20: <i>Outside view of two storey soil brick house in Kökan-Bayramyazi</i> | 23 |
| Figure 21: <i>Two storey soil brick house in Incedal village-backside view</i> | 24 |
| Figure 22: <i>Two storey soil brick house in Incedal village-front view</i> | 24 |
| Figure 23: <i>Two storey soil brick house with a stall in the ground floor, front view, Okcular</i> .. | 25 |
| Figure 24: <i>Two storey soil brick house with a stall in the ground floor (only lintel application ever seen in that area), side view, Beyhani</i> | 25 |
| Figure 25: <i>Two storey soil brick house with a stall in the ground floor (only lintel application ever seen in that area), side view, Beyhani</i> | 26 |

| | |
|--|----|
| Figure 26: <i>One story typical school building, Okcular village</i> | 27 |
| Figure 27: <i>Two storey light stone house, with a stall as ground floor, Okcular village</i> | 27 |
| Figure 28: <i>Upper floor of two storey light stone house, with a stall as ground floor, Okcular village</i> | 28 |
| Figure 29: <i>Ground floor of two storey light stone house, with a stall as ground floor, Okcular village</i> | 28 |
| Figure 30: <i>Two storey light stone house, with a stall as ground floor, Okcular village</i> | 29 |
| Figure 31: <i>Two storey house, with a combination of heavy stones in the ground floor, and light stones in the upper floor, Okcular village</i> | 29 |
| Figure 32: <i>Two storey light stone house, constructed in 1987, Okcular village</i> | 30 |
| Figure 33: <i>Two storey light stone house, Okcular village</i> | 30 |
| Figure 34: <i>Two storey heavy stone house, back side view, Okcular village</i> | 31 |
| Figure 35: <i>Two storey heavy stone house, side view, Okcular village</i> | 31 |
| Figure 36: <i>Two storey heavy stone house, side view, Beyhani</i> | 32 |
| Figure 37: <i>Two storey heavy stone house, inside view, Beyhani</i> | 32 |
| Figure 38: <i>Two storey heavy stone house, inside view, Beyhani</i> | 33 |
| Figure 39: <i>Outside view of two storeys mixed structural system, Okcular village</i> | 34 |
| Figure 40: <i>Inside view of two storeys mixed structural system, RC beam, RC slab, infill brick wall, Okcular village</i> | 34 |
| Figure 41: <i>Inside view of two storeys mixed structural system, RC beam, RC slab, heavy stone wall, Okcular village</i> | 35 |
| Figure 42: <i>Inside view of two storeys mixed structural system, RC beam, RC slab, heavy stone wall, Okcular village</i> | 35 |
| Figure 43: <i>Inside view of two storeys mixed structural system, RC beam, RC slab, heavy stone wall, Okcular village</i> | 36 |
| Figure 44: <i>Inside view of two storeys mixed structural system, RC beam, RC slab, heavy stone wall, Okcular village</i> | 36 |
| Figure 45: <i>Inside view of two storeys mixed structural system, RC beam, RC slab, heavy stone wall, Okcular village</i> | 37 |
| Figure 46: <i>Inside view of two storeys mixed structural system, RC beam, RC slab, heavy stone wall, Okcular village</i> | 37 |
| Figure 47: <i>One storey house, built with infill bricks, Aşağıkanatlı village</i> | 38 |
| Figure 48: <i>Outside view of three storey house, infill bricks filled with concrete as load bearing walls, in Okcular</i> | 38 |

| | |
|---|----|
| Figure 49: <i>Outside view of the mosque, Incedal village</i> | 39 |
| Figure 50: <i>Outside view of the mosque, Incedal village</i> | 39 |
| Figure 51: <i>Outside view of the mosque, Incedal village</i> | 40 |
| Figure 52: <i>Outside view of the mosque, Incedal village</i> | 40 |
| Figure 53: <i>Outside view of the mosque, Incedal village</i> | 41 |
| Figure 54: <i>Outside view of the mosque, Incedal village</i> | 41 |
| Figure 55: <i>Inside view of the mosque, Incedal village</i> | 42 |
| Figure 56: <i>Inside view of the mosque, Incedal village</i> | 42 |
| Figure 57: <i>Refractory brick houses built after 1971 Bingol earthquake, Okcular</i> | 43 |
| Figure 58: <i>Refractory brick houses built after 1971 Bingol earthquake, Okcular</i> | 43 |
| Figure 59: <i>Refractory brick houses built after 1971 Bingol earthquake, Okcular</i> | 44 |
| Figure 60: <i>Refractory brick houses built after 1971 Bingol earthquake, Yukarikanatlı village</i> | 44 |
| Figure 61: <i>Prefabricated panel houses built after 1971 Bingol earthquake, still in use, Incedal village</i> | 45 |
| Figure 62: <i>Prefabricated panel houses built after 1971 Bingol earthquake, being used as storage room, Incedal village</i> | 45 |
| Figure 63: <i>RC house, without any damage in beam-column joints, Okcular village</i> | 46 |
| Figure 64: <i>RC house, without any damage in beam-column joints, Okcular village</i> | 46 |
| Figure 65: <i>RC house, without any damage in beam-column joints, Okcular village</i> | 47 |
| Figure 66: <i>RC house, built by government, after 2003 Bingol earthquake, Tabanözü village</i> | 47 |
| Figure 67: <i>RC house, built by government, after 2003 Bingol earthquake, Incedal village</i> ... | 48 |
| Figure 68: <i>RC house, built by government, after 2003 Bingol earthquake, Incedal village</i> ... | 48 |
| Figure 69: <i>RC house, built by government, after 2003 Bingol earthquake, Incedal village</i> ... | 49 |
| Figure 70: <i>RC house, built by government, after 2003 Bingol earthquake, Incedal village</i> ... | 49 |
| Figure 71: <i>RC house, built by government, after 2003 Bingol earthquake, Incedal village</i> ... | 50 |
| Figure 72: <i>Only vertical lintel application ever seen, Beyhani-Palu</i> | 52 |
| Figure 73: <i>Out of plane failure in one story, stone school building (being used for storage), Gocmezler village</i> | 52 |
| Figure 74: <i>Out of plane failure due to length of wall in two story stone house, Okcular village</i> | 53 |
| Figure 75: <i>Out of plane failure due to lack of integrity between soil brick and stone walls in one story house, Aşağıkanatlı village</i> | 53 |

| | |
|--|----|
| Figure 76: <i>Out of plane failure in two story stone houses, Okcular village, in both pictures “lack” of rigid diaphragm effect is visible, as well as bad integrity of walls constructed with different materials.</i> | 54 |
| Figure 77: <i>Out of plane failure in one story stone house, Yukarıkanatlı village</i> | 54 |
| Figure 78: <i>Thick soil layer on the roof, Kayalık village</i> | 55 |
| Figure 79: <i>Insufficient interlock among the rounded stones, Okçular village</i> | 55 |
| Figure 80: <i>Wide cracks following the mortar, Yukarıdemirci village</i> | 56 |
| Figure 81: <i>Wide cracks following the mortar, school building side view, Kayalık village</i> | 56 |
| Figure 82: <i>Wide cracks following the mortar, Okcular village</i> | 57 |
| Figure 83: <i>Wide cracks around openings, Beyhan-Palu</i> | 57 |
| Figure 84: <i>Improperly arranged stone walls, İncedal village</i> | 57 |
| Figure 85: <i>Single example of properly arranged, layered, triangular shaped, one story house, inside walls are soil bricks, Tabanözü village</i> | 58 |
| Figure 86: <i>Lower ground floor, being used as a stall, İncedal village</i> | 58 |
| Figure 87: <i>Outside view of two storey soil brick house in Kökan-Bayramyazı-1</i> | 59 |
| Figure 88: <i>Inside view of two storey soil brick house in Kökan-Bayramyazı-2</i> | 59 |
| Figure 89: <i>Inside view of two storey soil brick house in Kökan-Bayramyazı-3</i> | 60 |
| Figure 90: <i>Inside view of two storey soil brick house in Kökan-Bayramyazı-4</i> | 60 |
| Figure 91: <i>Inside view of two storey soil brick house in Kökan-Bayramyazı-5</i> | 61 |
| Figure 92: <i>Inside view of two storey soil brick house in Kökan-Bayramyazı-6</i> | 61 |
| Figure 93: <i>Inside view of two storey soil brick house in Kökan-Bayramyazı-7</i> | 62 |
| Figure 94: <i>Inside view of two storey soil brick house in Kökan-Bayramyazı-8</i> | 62 |
| Figure 95: <i>Inside view of two storey soil brick house in Kökan-Bayramyazı-9</i> | 63 |

List of Tables

| | |
|---|----|
| Table 1: <i>Earthquake parameters, defined by KOERI</i> | 8 |
| Table 2: <i>Distance between epicenter and residential areas</i> | 8 |
| Table 3: <i>Numbers of heavily damaged earthquakes and human loss in previously occurred earthquakes</i> | 9 |
| Table 4: <i>Losses, based on observations till 29.03.2010 (source: Elazığ Governorship official web site)</i> | 10 |
| Table 5: <i>Earthquake source parameters</i> | 13 |
| Table 6: <i>Total number of buildings and population exposed to earthquake motion</i> | 18 |
| Table 7: <i>Estimated total number of damaged buildings in different damage states</i> | 19 |
| Table 8: <i>PGA and distance information of Strong Ground Motion Stations</i> | 20 |
| Table 9: <i>Classification of damage to masonry buildings in European Macroseismic Scale</i> ... | 51 |

1 Introduction

An earthquake occurred on March 8, 2010 at 04:32 local time, in Elazığ province, Başyurt Karakoçan region of which magnitude is defined as $M_l=6.9$ by Kandilli Observatory and Earthquake Research Institute (KOERI), having an intensity of $I_0=VII$. This shallow earthquake was intensively felt especially in Kovancılar, Başyurt, Karakoçan, Gökdere and Elazığ, while its effectiveness decreased around Giresun, Erzurum, Erzincan, Batman, Tunceli, Malatya, Bingöl, Diyarbakır. Based on the initial observations, approximately one hundred villages have been affected, 42 people died, and 137 people injured. Distribution of life losses is as following; Okçular village 19, Yukarı Demirci village 14, Kayalık village 3, Göçmezler village 3, Yukarı Kanatlı village 3. Damage densities in the region which is between Okçular, Karasungur, Yukarı Mirahmet and İsağa, near to epicenter.

Table 1: Earthquake parameters, defined by KOERI

| Date | O. Time (L.T.) | Lat.-Long. N-E | Depth (km) | Magnitude | | Intensity (I_0) | Location |
|------------|-------------------|-------------------|---------------|-----------|-------|------------------------|-----------------------|
| | | | | M_l | M_w | | |
| 08.03.2010 | 04:32 | 38.807-40.100 | 5.0 | 6.0 | 6.0 | VII | Başyurt- Karakoçan |

Table 2: Distance between epicenter and residential areas

| Residential Area | Distance to epicenter (km) | Proximity | Residential Area | Distance to epicenter (km) | Proximity |
|------------------|----------------------------|-----------|------------------|----------------------------|-----------|
| Karasungur | 3.6 | 1 | Başyurt | 10.2 | 11 |
| İsağa Mz. | 4.2 | 2 | Gökdere | 11.2 | 12 |
| A. Kanatlı | 4.5 | 3 | Kayalık | 13 | 13 |
| Durmuşlar | 4.5 | 4 | Palu | 19.8 | 14 |
| Tabanözü | 4.7 | 5 | Kovancılar | 22.1 | 15 |
| Okçular | 4.8 | 6 | Y. Kanatlı | 31.2 | 16 |
| A. Demirci | 5.6 | 7 | Elazığ | 75.3 | 17 |
| Bayramyazı | 8.3 | 8 | Sivrice | 77.1 | 18 |
| Göçmezler | 8.6 | 9 | Karakoçan | 109.3 | 19 |
| Y. Demirci | 10 | 10 | | | |

Most damaged villages are Okçular, Yukarı Kanatlı, Yukarı Demirci, Aşağı Kanatlı, Karasungur, İsağa, Durmuşlar, Tabanözü, Aşağı Demirci, which are between Başyurt, Kovancılar and Gökdere towns.

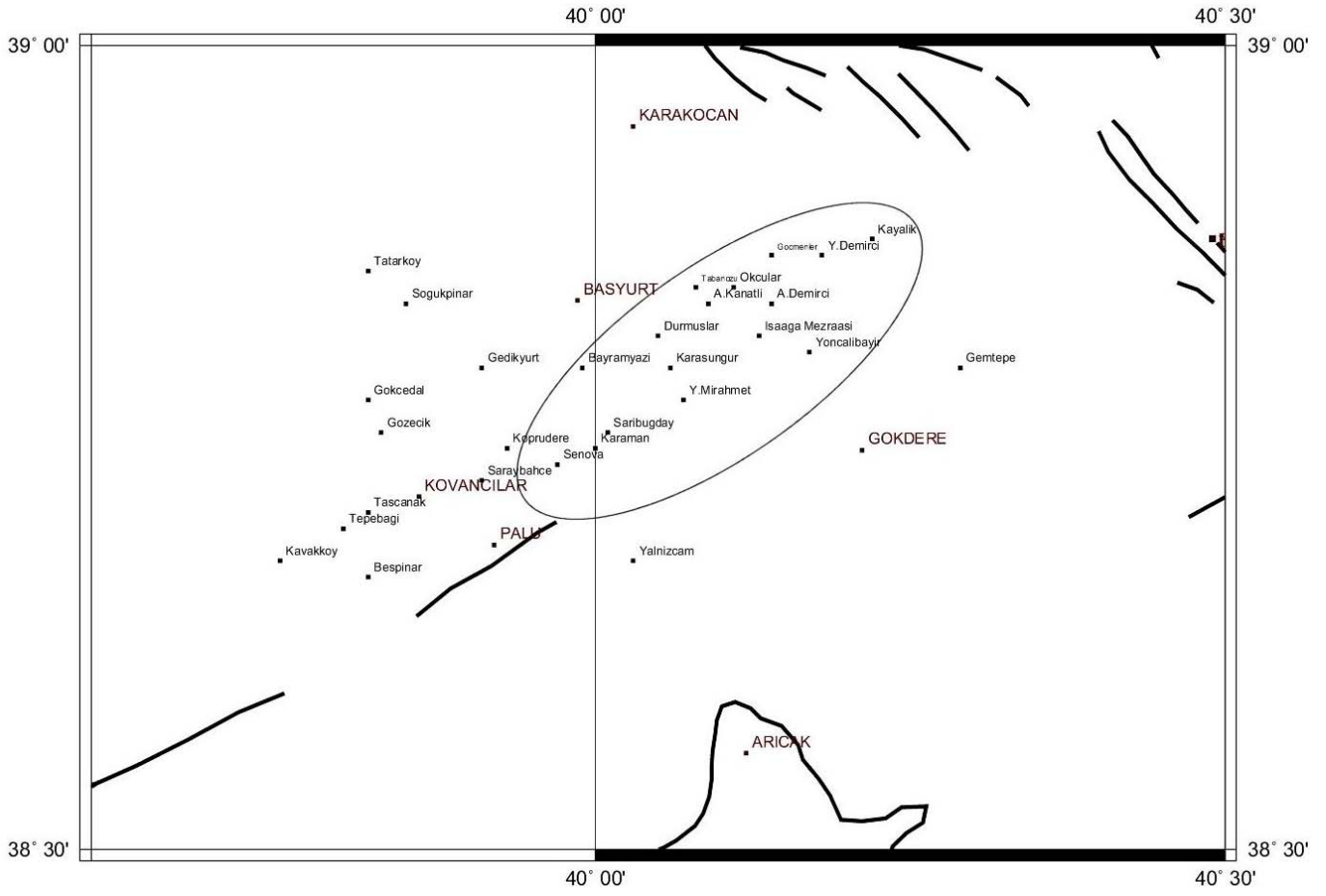

Figure 1: Area of which the earthquake became more effective

In below table, number of human life loss and number of heavily damaged buildings due to previously occurred earthquakes are presented. As it can be observed from the table, the ratio between the numbers of heavily damaged buildings (including collapse) and human life loss depends on the magnitude of earthquake. In other words, ratio of heavily damaged buildings to human loss increases with decreasing magnitude of earthquake.

Table 3: Numbers of heavily damaged earthquakes and human loss in previously occurred earthquakes

| | | Magnitude | Number of Heavily Damaged Buildings (NHDM) | Casualties (C) | NHDM/C |
|------|------------------------------|-----------|--|----------------|--------|
| 2003 | Bingöl Earthquake. | Ms 6.4 | 1602 | 177 | 9.1 |
| 1983 | Erzurum-Kars Earthquake | Ms 7.1 | 3240 | 1400 | 2.3 |
| 1976 | Çaldıran-Muradiye Earthquake | Ms 7.5 | 9232 | 3840 | 2.4 |
| 1971 | Bingöl Earthquake | Ms 6.8 | 5000 | 755 | 6.6 |
| 1943 | Çorum Earthquake | Ms 7.2 | 2554 | 618 | 4.1 |
| 1939 | Erzincan Earthquake | Ms 7.9 | 116720 | 32968 | 3.5 |

Distribution of heavily damaged buildings and total number of human loss, due to Başyurt-Karakoçan earthquake, are presented in below table, provided by Elazığ Governorship. The ratio of heavily damaged buildings over human loss is; $3007/42=71.6$. If we compare this ratio with above mentioned ratios of previous earthquakes, having almost similar building stock, even if we consider the effect of decreasing magnitude, there is a serious discrepancy. Since the number of human loss is certain, it could be better to reconsider the number of heavily damaged buildings. Also, total number of buildings (8422) is quite a big amount if the number of affected people is around 10.000 and population of the area that earthquake became effective.

Table 4: Losses, based on observations till 29.03.2010 (source: Elazığ Governorship official web site)

| | |
|---|--|
| Number of effected residential areas (of which initial post earthquake assessment is done) | 337 |
| Effected population (Approximately) | 10.000 |
| Human life loss | 42 |
| Number of injured | 137 |
| Injured people in hospitals | 7 |
| Animal life loss | Cattle : 235 Ovine : 2797 Single shank: 9 Bee cell : 20 |
| Number of damaged houses (of which initial post earthquake assessment is done) | Light : 3854 Moderate : 1561 Heavy : 3007 Total : 8422 |
| Number of damaged stalls (of which initial post earthquake assessment is done) | Light : 1736 Moderate : 878 Heavy : 2200 Total : 4814 |
| Number of damaged shops/small business buil. (of which initial post earthquake assessment is done) | Light : 485 Moderate : 158 Heavy : 234 Total : 877 |

Aftershocks have been occurred as distributed along southwest (SW) to northeast (NE) direction. Red star shows the main shock, blue star shows the biggest aftershock and purple circles show the earthquakes of which magnitude varies between 4.0-4.9.

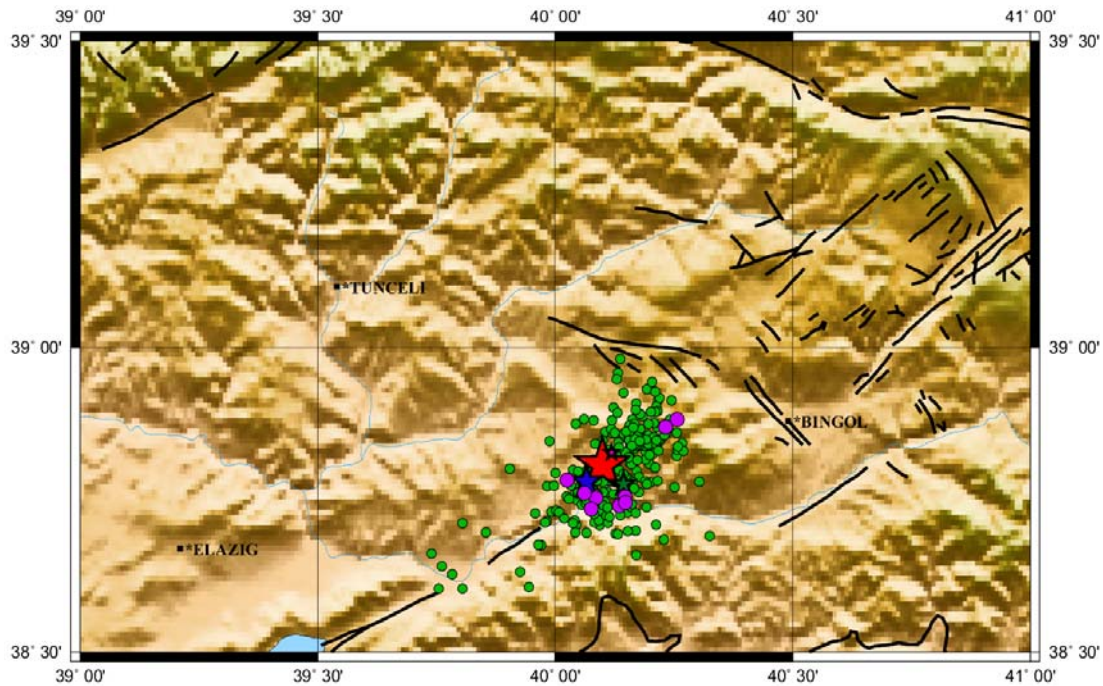

Figure 2: Distribution of aftershocks

2 Regional Geology

The settlement areas in the region are located within the earthquake zone of 1 (Kovancılar and Palu) and 2 (Karakoçan). The geological units in the earthquake affected area especially between Gokdere and Basyurt region are formed by Holocene aged young alluvium units, Andesite, Spilite, Porfirite units, Eocene aged Filish and partly Serpentine units. Alluviums take place in river beds, Hillside debris (talus) is seen in northern parts. In general the villages are settled on these units in slope areas.

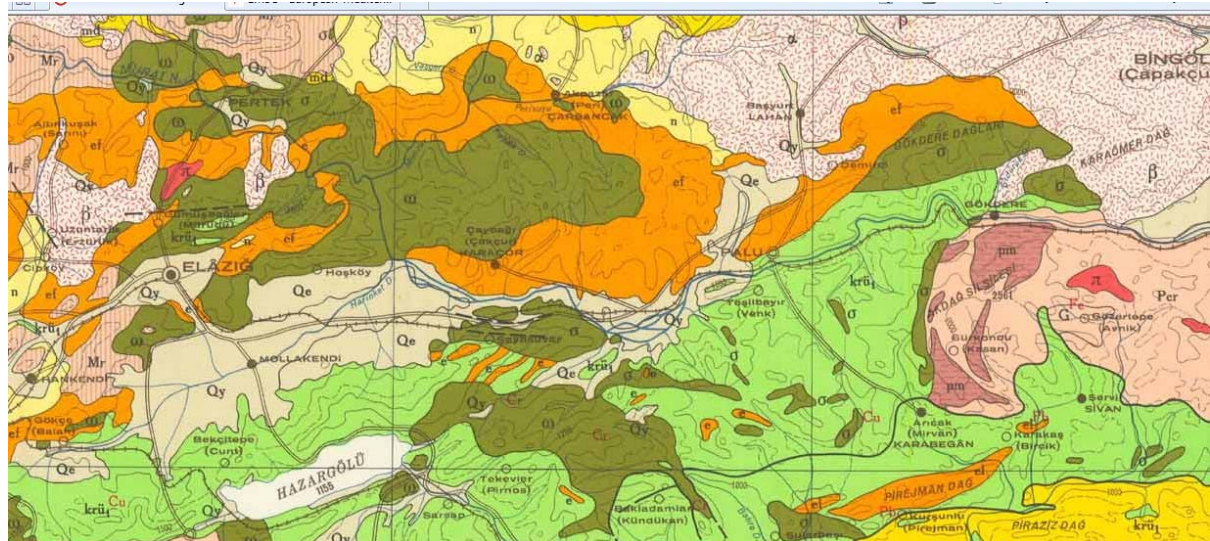

Figure 3: Geology map of the region

3 Seismo-tectonic Characteristics of the Region

Başyurt-Kovancılar-Gökdere region where the main shock has occurred is located within the East-Anatolian Fault Zone (EAFZ). In Turkish Earthquake Zoning Map, the region is placed in partly Zone-1 and Zone-2, and it is within the significant deformation area. The region is positioned between North-Anatolian Fault Zone (NAFZ) and EAFZ, and shows high seismicity due to the active fault systems and multi-rupture characteristics.

The 1789 Palu (Io=VIII; 51.000 casualties, faulting=20 km.), 1866 Southern Hazar Lake - Elazığ (Io=VIII), 1874 Harput-Elazığ-Diyarbakır (Io=VIII) and 1875 Karlıova-Bingöl-Palu-Elazığ (Io=VIII; M=6.1) earthquakes are important historical earthquakes in the region (Soysal et al., 1981). In instrumental period, 1949 Karlıova (Io=IX; Ms=6.7), 1971 Bingöl (Io=VIII; Ms=6.8), 1975 Lice (Io=VIII; Ms=6.6), 2003 Pulumur (Io=VII; Ms=6.2), 2003 Bingöl (Io=VIII; Ms=6.4) and 2004-2007 Sivrice earthquakes (Ml=5.5-5.9) affected the region.

The eastern part of EAFZ which is formed by many left-lateral segments starting from Karlıova region proceeds to southern-west with Palu-Hazar Golu segment. The main shock and the aftershocks of March 08, 2010 earthquake are related with EAFZ, and they occurred in Palu-Hazar Lake fault segment.

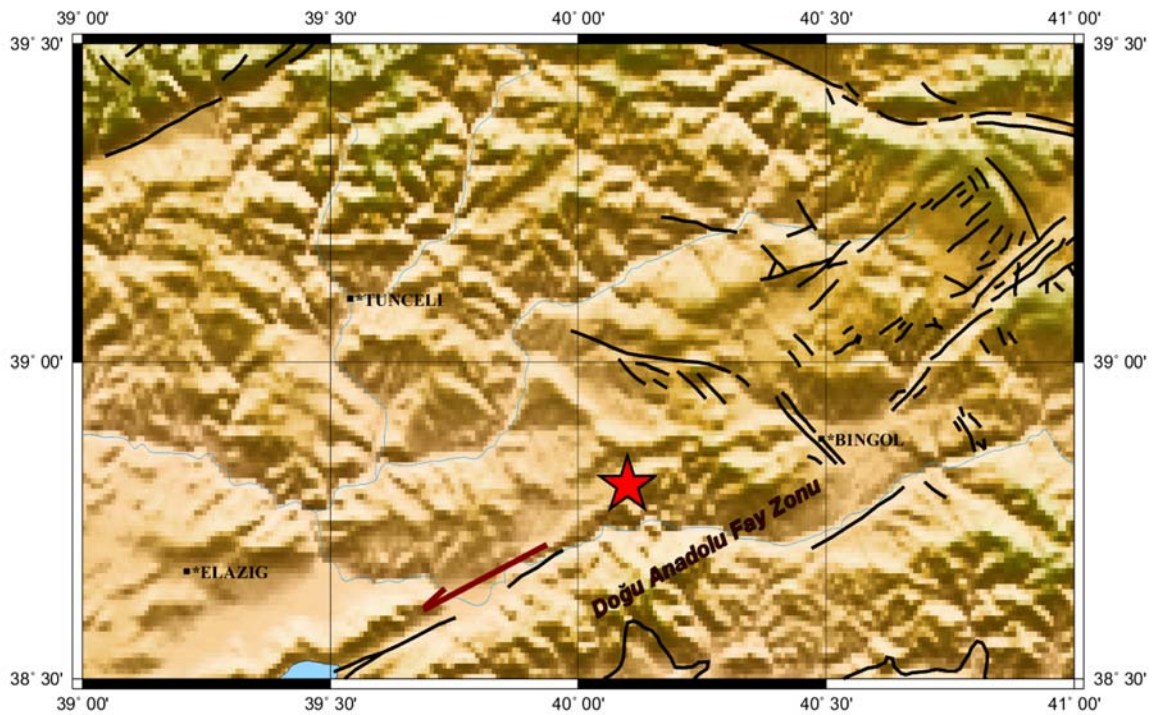

Figure 4: The location of the March 08 2010 earthquake epicenter on active fault map (Saroglu et.al., 1992, MTA)

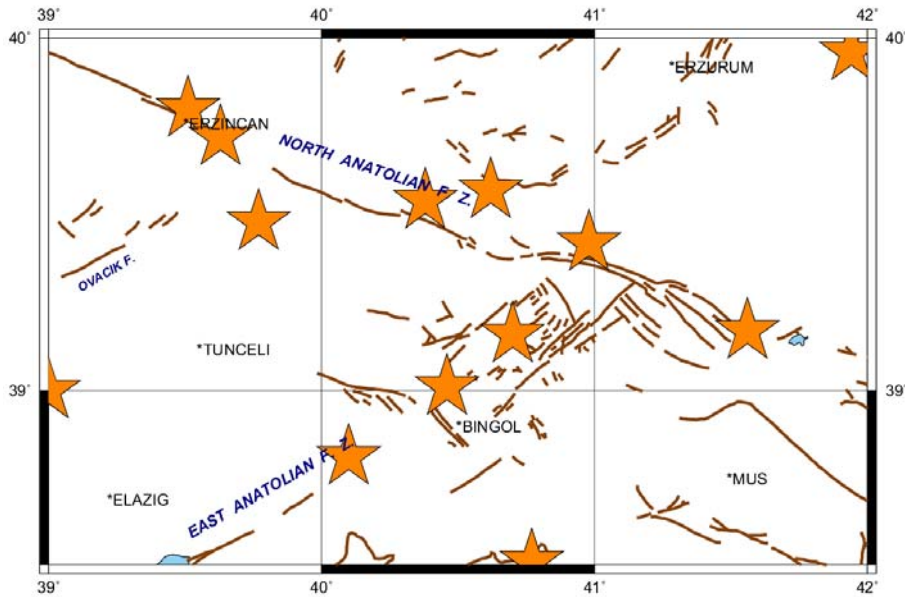

Figure 5: The distribution of the major earthquakes in the region (1900-2009; $M \geq 6.0$)

4 Earthquake Source Parameters

The fault mechanism solutions, done by KOERI after the earthquake, showed that the earthquake has a left-lateral faulting mechanism. The source parameters of the earthquake are given in table below;

Table 5: Earthquake source parameters

| Source Parameter of Başyurt-Karakoçan (Elazığ-Eastern Turkey) Earthquake | | | | | | | | | | |
|--|--------------------------|--------------|--------------|-------------|-----------------------------------|-------------------------|--|--------------------|--------------------|----------------------------|
| Date d/m/y | O.Time h/m/s U.T.C | Lat. deg. | Lon. deg. | Dep. km. | Seismic Moment M_0 dyn.cm | Moment Mag. M_w | Fault Plane Parameters NP1 strike/dip/rake | P axis Az./Plg. | T axis Az./Plg. | Location |
| 08.03.2010 | 02:32:31 | 38.798 | 40.156 | 4 | $1.30E+25$ | 6.0 | 33/74/-30 | 4.9/46.0 | 264.6/9.8 | Başyurt-Karakoçan (ELAZIĞ) |

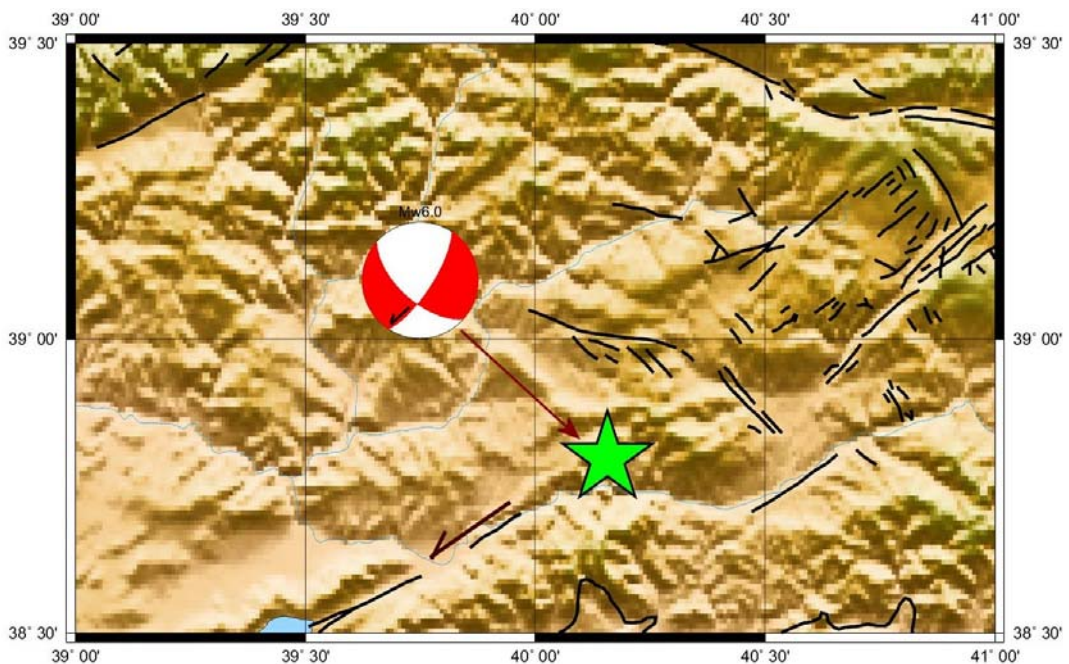

Figure 6: Faulting mechanism

5 Statistical Characteristics of the Earthquake

Başyurt-Karakoçan earthquake had a shallow focus. As shown in the picture below, aftershocks are shallow as well; depths are smaller than 7.5 and 15.1 km.

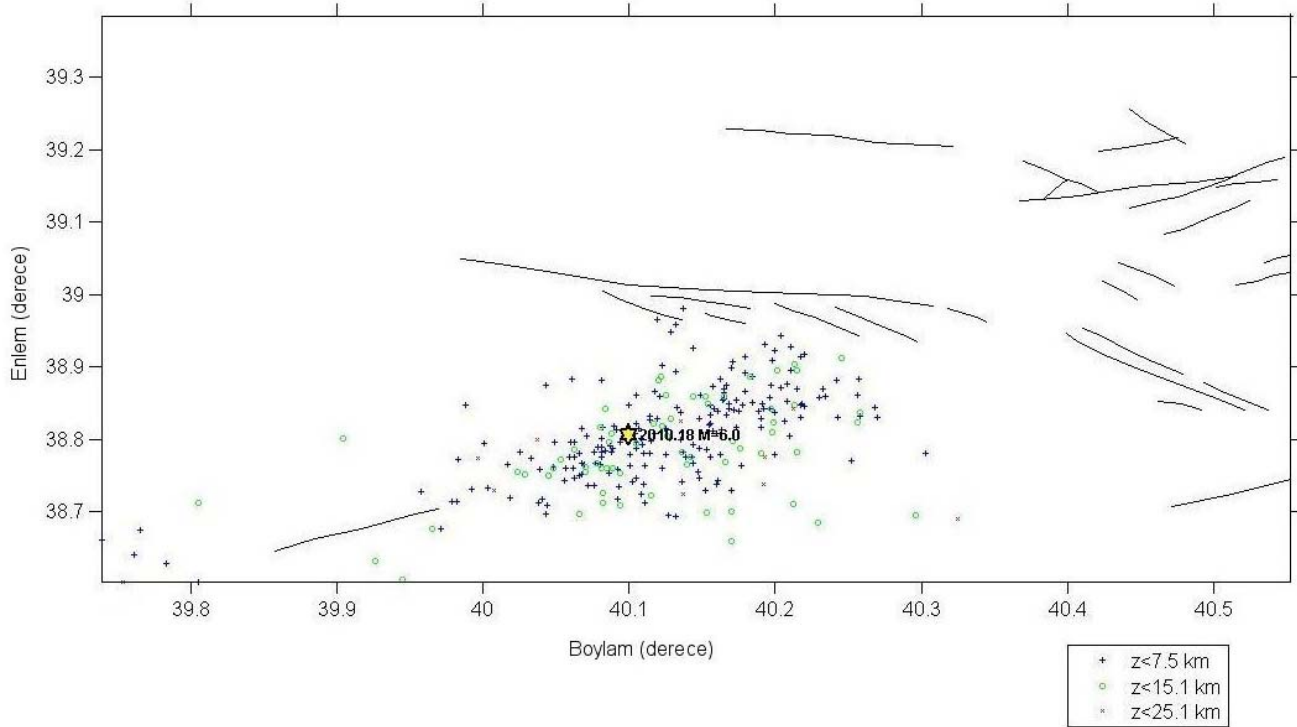

Figure 7: Distribution of aftershocks and depths of aftershocks

Analyzed earthquakes, occurred between 8th and 22nd of March, are having a magnitude in the range of 2.2-3.2 and a focus depth of approximately 5 km.

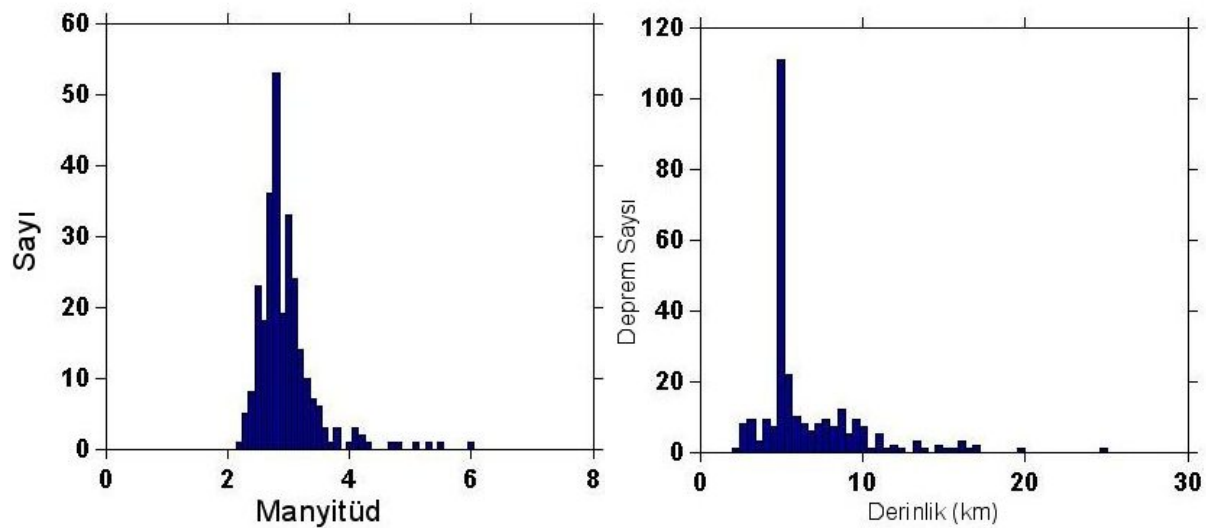

Figure 8: Number of Earthquakes vs Magnitude and Number of Earthquakes vs Depth Histograms

Aftershocks were quite often especially in the first week after the main shock and decreased in the third week. As we see in the below pictures showing distributions of earthquakes with time period during the day, almost 7 earthquake occurred in every hour, and sometimes this number exceeded 20.

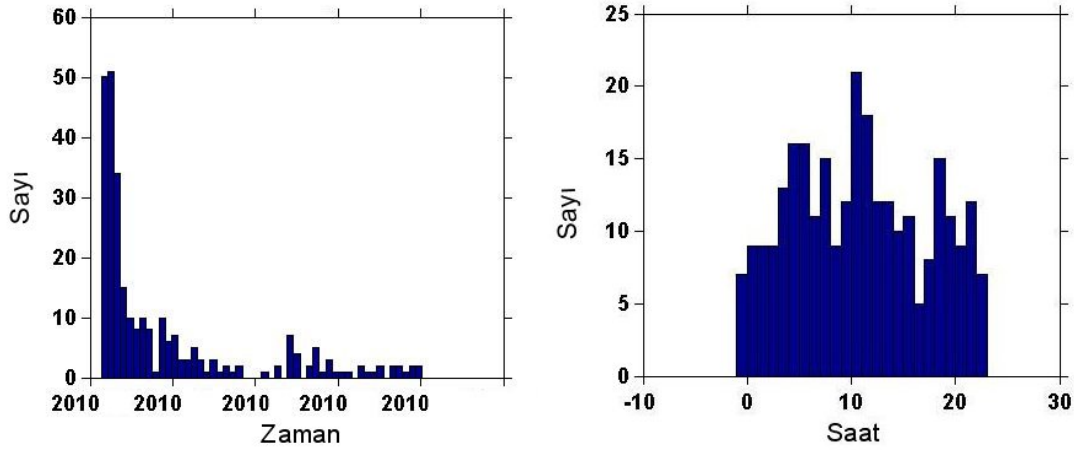

Figure 9: Number of Earthquakes vs. Time and Number of Earthquakes vs. Hour Histograms

As obtained from graphs, during the seismic activities in three weeks period, number of earthquakes and big portion of released energy are densifying in the first couple of days.

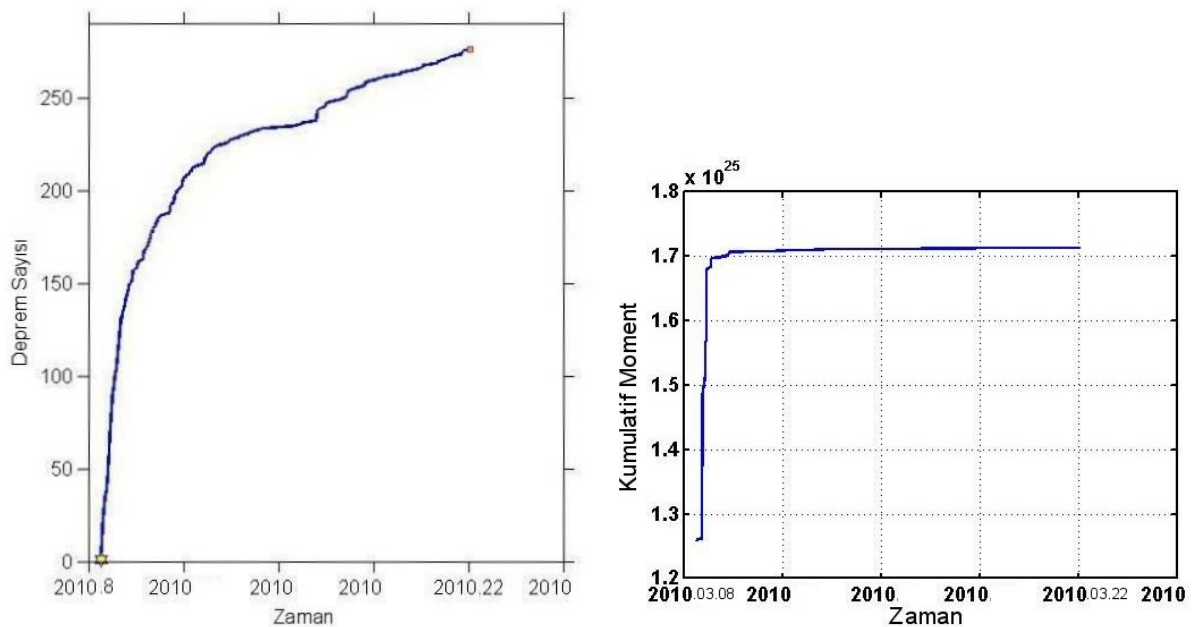

Figure 10: Cumulative Number of Earthquakes vs. Time and Cumulative Moment vs. Time

6 Real-time Earthquake Shaking and Damage Estimations

ELER (Earthquake Loss Estimation Routine) which has been developed by Earthquake Engineering Department (EED) of Kandilli Observatory and Earthquake Research Institute (KOERI), Bogazici University has been applied for real-time earthquake shaking estimations immediately after the earthquake.

The magnitude and epicenter information obtained from KOERI, National Earthquake Monitoring Center (NEMC) has been used to simulate a point source earthquake intensity distribution immediately after the earthquake as shown in Figure 11. Here, the maximum intensity in epicentral area is found as VII. This result is compatible with field observations.

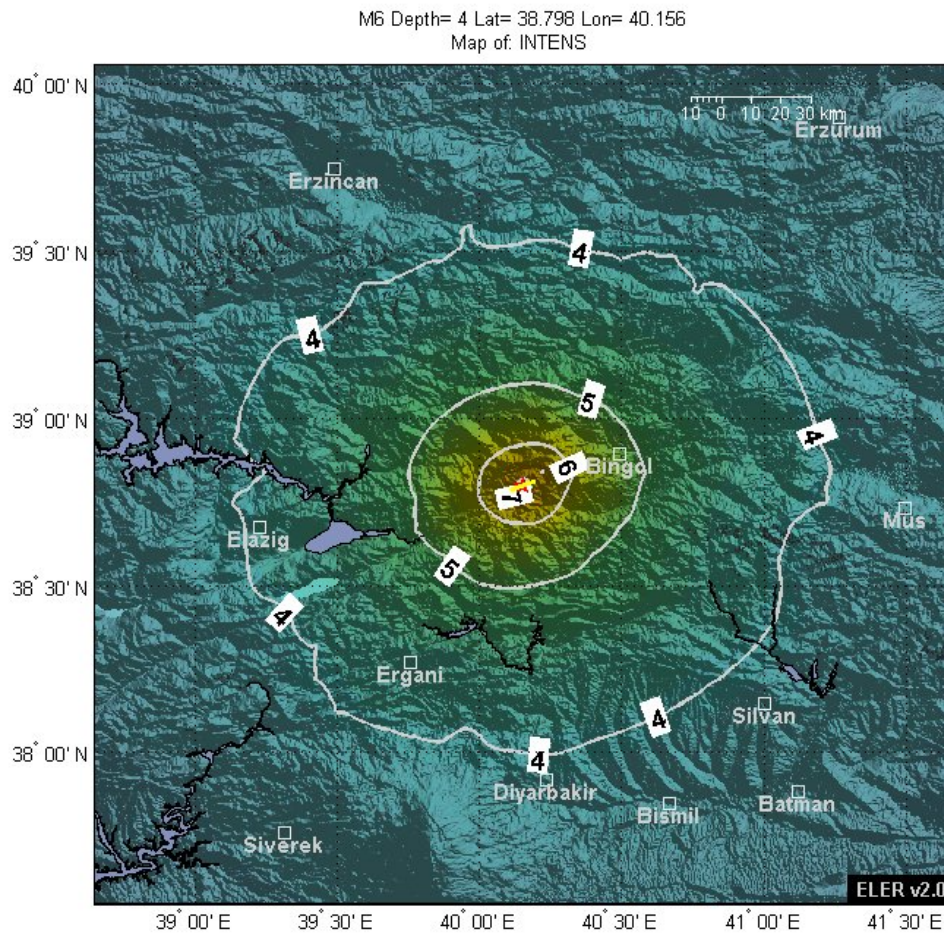

Figure 11: Probable Intensity Map

The estimated PGA distribution map has been developed as shown in Figure 12 by using intensity-PGA relations. In epicentral area PGA has been estimated approximately as 37cm/s^2 . This is also well-matched with information obtained from stations as given in Section.7.

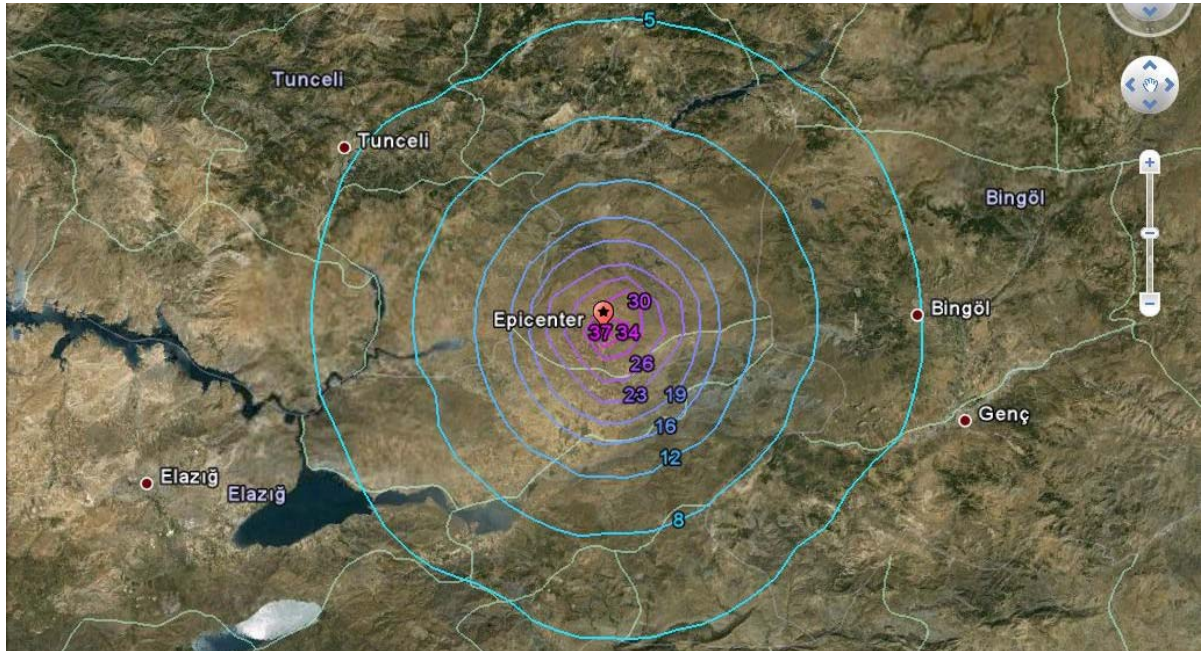

Figure 12: Probable peak acceleration map

This obtained information from stations has been used to modify real-time intensity, ground motion parameters maps and subsequently damage and casualty maps.

In Figure 13, the modified intensity map with stations' ground motion information and fault information by using Campbell and Bozorgnia attenuation relation is presented.

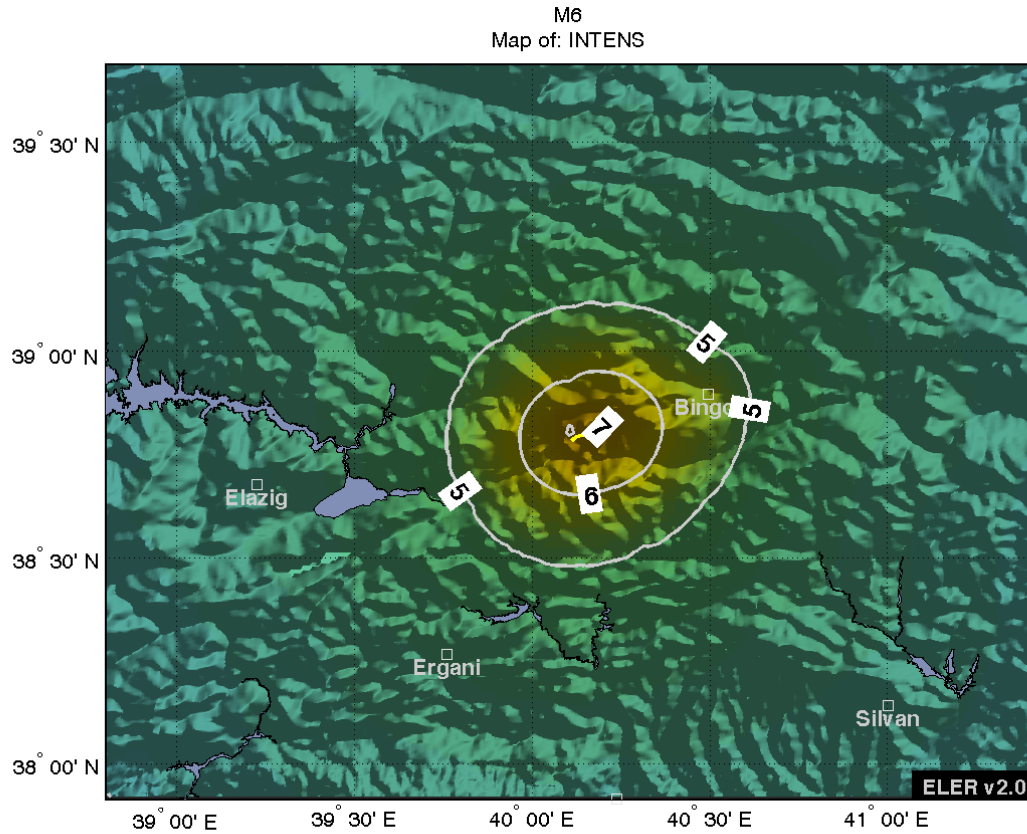

Figure 13: Modified Intensity Map

The total numbers of buildings and population exposed to earthquake motion in each seismic intensity zone are given in Table 6.

Table 6: Total number of buildings and population exposed to earthquake motion

| | Intensity | Stations + Fault Information | | | | Point Source |
|----------------------------------|-----------|--------------------------------------|---------------------------------|----------------------------------|---------------------------------|--------------------------------------|
| | | Campbell & Bozorgnia 2007 | | Boore & Atkinson 2007 | | Campbell & Bozorgnia 2007 |
| | | Wald 1999 | Atkinson & Kaka 2007 | Wald 1999 | Atkinson & Kaka 2007 | Wald 1999 |
| Total Number of Buildings | 3-4 | 105129 | 0 | 105274 | 2165 | 74263 |
| | 4-5 | 19810 | 166821 | 27483 | 159500 | 74576 |
| | 5-6 | 1199 | 13656 | 1075 | 19243 | 7967 |
| | 6-7 | 126 | 1677 | 0 | 1246 | 1616 |
| | 7-8 | 0 | 0 | 0 | 0 | 150 |
| Total Population | 3-4 | 1281569 | 0 | 1279045 | 14621 | 800284 |
| | 4-5 | 280360 | 2173924 | 368144 | 2094153 | 871105 |
| | 5-6 | 16383 | 201562 | 15104 | 273363 | 98839 |
| | 6-7 | 2017 | 24169 | 0 | 17518 | 24810 |
| | 7-8 | 0 | 0 | 0 | 0 | 2318 |

For validation purposes the PGA and PGV distributions have been calculated with 2 different ground motion attenuation relationships, namely Campbell & Bozorgnia and Boore & Atkinson, these ground motions have been used as input parameters for the intensity estimation approaches developed by Wald and Atkinson & Kaka. The damage estimations of these four different intensity simulations are given in Table 7 by using European Macroseismic Scale (EMS-98, Grunthal, 1998).

Table 7: *Estimated total number of damaged buildings in different damage states*

| PGA PGV Intensity | Campbell & Bozorgnia 2007 | Boore & Atkinson 2007 |
|----------------------------------|---|--|
| Wald 1999 | D5: 0 D4: 1 D3: 25 D2: 269 D1: 2162 | D5: 0 D4: 1 D3: 27 D2: 298 D1: 2407 |
| Atkinson & Kaka 2007 | D5: 0 D4: 7 D3: 109 D2: 952 D1: 6359 | D5: 0 D4: 6 D3: 116 D2: 1034 D1: 6870 |

The estimated casualty distribution map by using Samardjieva and Badal, 2002 approach has been provided in Figure 14.

Distribution of Casualties (Samardjieva and Badal 2002)
 Total Casualties: 67

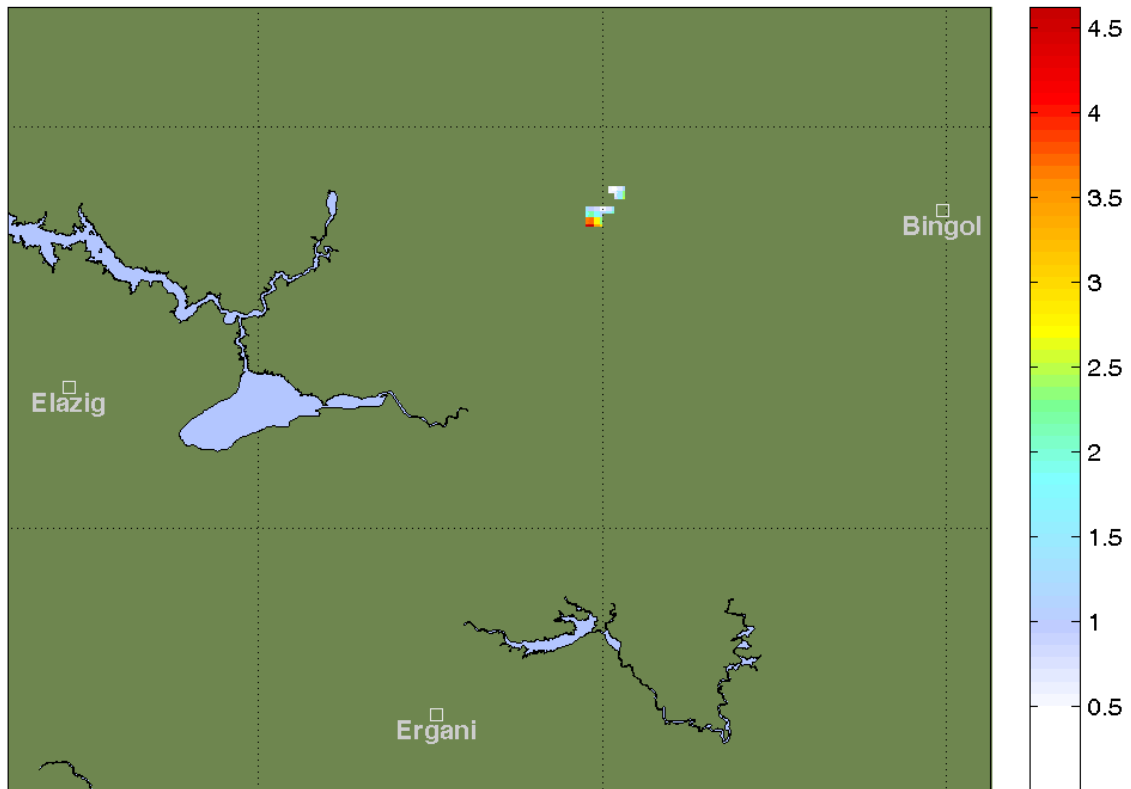

Figure 14: *The resulting casualties calculated immediately after the main shock*

7 Strong Motion Records

9 stations belonging to Turkey National Strong Motion Network has recorded the main shock. The acceleration records have been distributed through Turkey National Strong Motion Network's web-site (<http://daphne.deprem.gov.tr>). The PGA values in these stations and the stations' epicentral distances are given in Table-5, and the acceleration waveforms are shown on the map in Figure-13.

Table 8: PGA and distance information of Strong Ground Motion Stations

| Station Codes | PGA (cm/s ²) | | | Distance (km) |
|---------------|--------------------------|-------|-------|---------------|
| | NS | EW | UD | |
| 2301 | 5.56 | 4.77 | 3.85 | 73.70 |
| 1201 | 55.31 | 34.27 | 25.50 | 43.30 |
| 2303 | 62.00 | 66.50 | 30.00 | 12.20 |
| 1206 | 11.59 | 17.84 | 8.95 | 102.40 |
| 201 | 2.50 | 2.24 | 1.64 | 190.90 |
| 4701 | 2.54 | 2.46 | 1.68 | 172.00 |
| 7201 | 7.62 | 5.44 | 2.52 | 140.10 |
| 2101 | 3.44 | 5.10 | 2.59 | 94.90 |

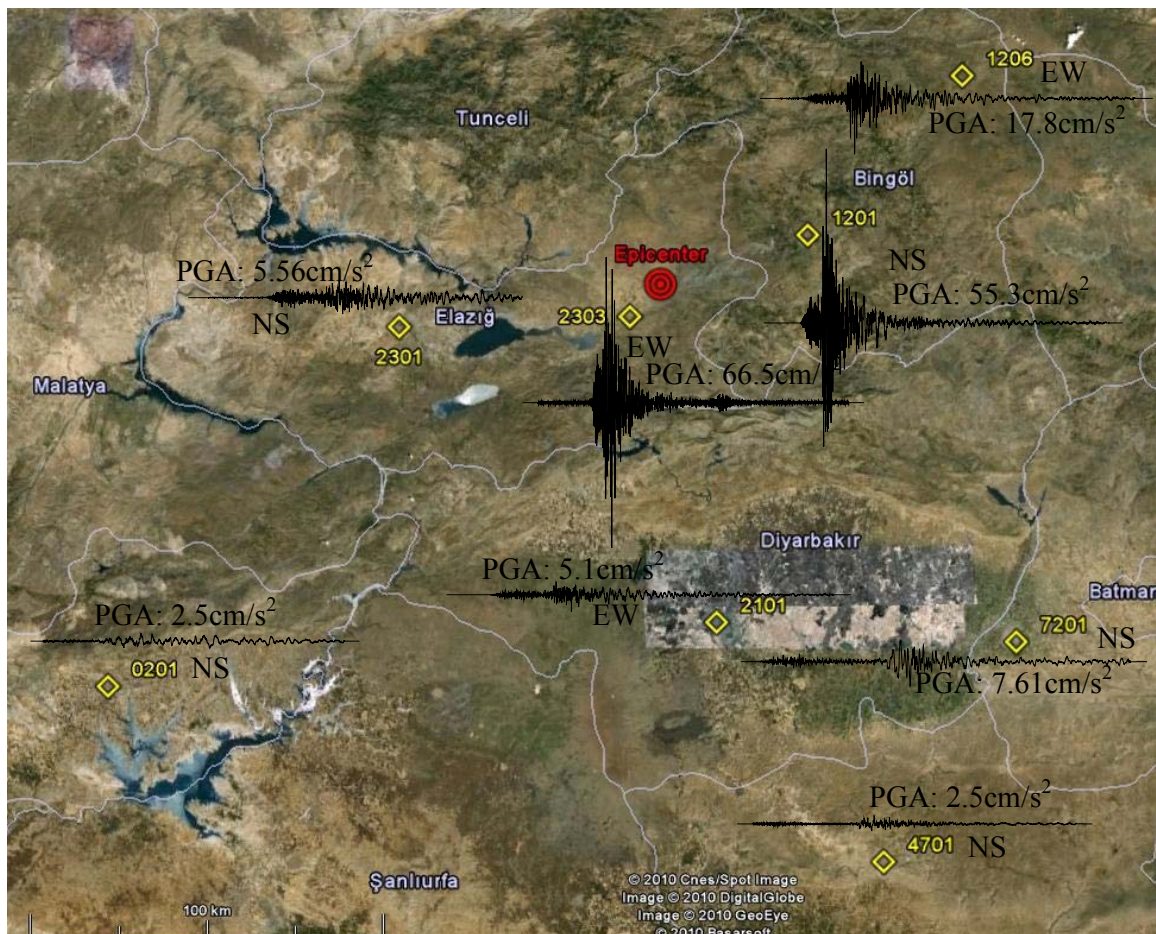

Figure 15: Location of National Strong Motion Stations and acceleration-time waveforms

Below figure shows the graph of PGA and distance relation and obtained attenuation relation equation.

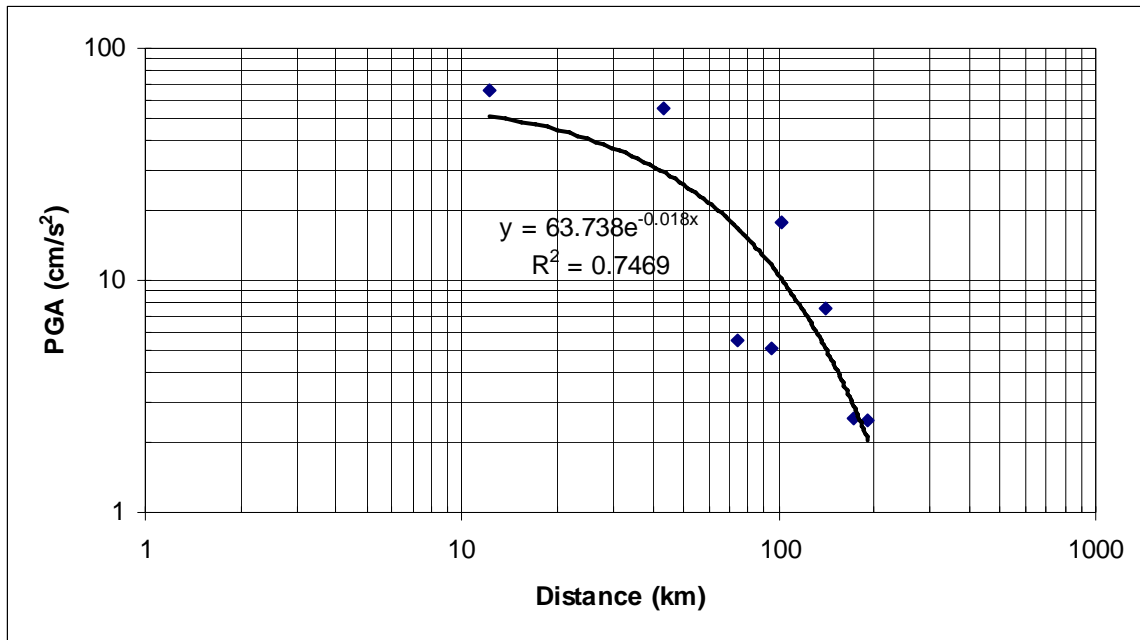

Figure 16: *PGA-Distance relation obtained from National Strong Ground Motion Network and obtained attenuation relation equation*

8 Building Types

Building types will be classified in terms of construction material, although, most of the buildings are constructed with binary combination of different materials. Also, these main groups are considered depending on the number of storeys, usage or the period of which it is constructed.

8.1 Masonry Houses with Sun-dried Soil Bricks

- Sun-dried soil brick (soil brick) is the most common construction material type especially for one storey houses and stalls. Approximate dimensions are shown in the below figure.

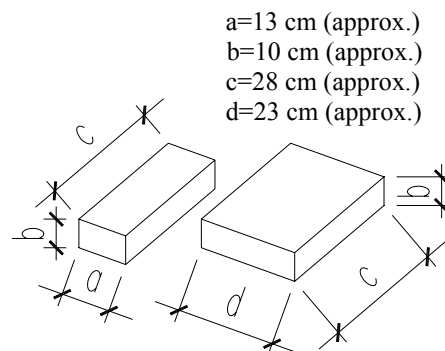

Figure 17: *Approximate sun-dried soil brick dimensions*

- Although, lack of confidence against soil brick houses already rose in the public's mind, big part of the building stock, especially old ones, is composed of soil brick houses.



Figure 18: *One storey soil brick house in Incedal village-side view 1 (bottom part of the house, below window level is built with stones)*



Figure 19: *One storey soil brick house in Incedal village-side view 2 (bottom part of the house, below window level is built with stones)*

- Also, some two storey soil brick houses can be seen of which the ground floor is used as a stall, while the upper floor is for accommodation. In this usage type, ground floor is approximately 2.5 m and upper floor is about 3.0 to 3.5 m height.



Figure 20: *Outside view of two storey soil brick house in Kökan-Bayramyazi*



Figure 21: Two storey soil brick house in Incedal village-backside view



Figure 22: Two storey soil brick house in Incedal village-front view

- Slabs are usually wooden, which are “simply supported” by stall floor. However, there is a lack of restraint on the slab boundaries; therefore it may be more convenient to consider them as “sliding support”. In other words, poorly constructed slabs and roofs are not capable to behave as a rigid diaphragm and transmit the lateral forces among the walls.



Figure 23: *Two storey soil brick house with a stall in the ground floor, front view, Okular*



Figure 24: *Two storey soil brick house with a stall in the ground floor (only lintel application ever seen in that area), side view, Beyhani*



Figure 25: Two storey soil brick house with a stall in the ground floor (only lintel application ever seen in that area), side view, Beyhani

8.2 Masonry Houses with Stones

- Relatively new buildings, starting from 1980's, are constructed with a kind of light, volcanic stone, coming from Güllüce, in that territory. This stone can be reshaped very easily; therefore, it is so common to see as outer walls of the buildings. It has been observed that in the outer walls, two layers were formed with these stones and the space between the layers is filled with rubble (smaller, rounded stones).
- As in the case of soil brick houses, these light stones had been used in one storey or two storey buildings. One story examples are mostly typical school buildings which can be seen in almost every village. However, with the attempt in the education system for the last few years, students have been transported to the schools in the city centre of Kovancılar. Therefore, most of the school buildings are being used for out of purpose or they are empty. Although, stones are not really well organized, the mortar quality in these school buildings is better than the other residential ones.



Figure 26: *One story typical school building, Okcular village*

- In two story examples, it is not easy to define a particular damage pattern, but it can be seen that, with a slightly more proper construction technique, they did not collapse totally, although they have suffered from heavy damage. Damage potential and reasons will be mentioned more in the following chapters.
- Another stone type, seen in darker colour in the pictures, is heavy, rounded rocks, obtained from river sides, so it is a more common construction material in Beyhan town. They are mostly used to form the foundations of soil brick houses or with the combination of before mentioned light stones.
- Also, in most of the stone houses, inside walls were constructed with soil bricks.



Figure 27: *Two storey light stone house, with a stall as ground floor, Okcular village*



Figure 28: Upper floor of two storey light stone house, with a stall as ground floor, Okcular village



Figure 29: Ground floor of two storey light stone house, with a stall as ground floor, Okcular village



Figure 30: *Two storey light stone house, with a stall as ground floor, Okcular village*



Figure 31: *Two storey house, with a combination of heavy stones in the ground floor, and light stones in the upper floor, Okcular village*



Figure 32: *Two storey light stone house, constructed in 1987, Okcular village*



Figure 33: *Two storey light stone house, Okcular village*



Figure 34: *Two storey heavy stone house, back side view, Okcular village*



Figure 35: *Two storey heavy stone house, side view, Okcular village*



Figure 36: *Two storey heavy stone house, side view, Beyhani*



Figure 37: *Two storey heavy stone house, inside view, Beyhani*



Figure 38: *Two storey heavy stone house, inside view, Beyhani*

8.3 Masonry Houses with Infill Bricks

- Infill wall bricks (infill bricks) shown below, are used in many buildings as a structural, load bearing walls. In some of the examples, infill bricks are filled with concrete, and in the others they are used as empty.
- It is also possible in this construction type, to see reinforced concrete beams and slabs, supported by these infill bricks. Although, even some “reinforced concrete columns” are visible, structural system can not be defined as “reinforced concrete frame system”, because of incapable connections... In the below pictures, a stone-infill brick-beam-column system is shown.



Figure 39: *Outside view of two storeys mixed structural system, Okcular village*



Figure 40: *Inside view of two storeys mixed structural system, RC beam, RC slab, infill brick wall, Okcular village*



Figure 41: *Inside view of two storeys mixed structural system, RC beam, RC slab, heavy stone wall, Okular village*



Figure 42: *Inside view of two storeys mixed structural system, RC beam, RC slab, heavy stone wall, Okular village*



Figure 43: *Inside view of two storeys mixed structural system, RC beam, RC slab, heavy stone wall, Okcular village*



Figure 44: *Inside view of two storeys mixed structural system, RC beam, RC slab, heavy stone wall, Okcular village*



Figure 45: *Inside view of two storeys mixed structural system, RC beam, RC slab, heavy stone wall, Okular village*



Figure 46: *Inside view of two storeys mixed structural system, RC beam, RC slab, heavy stone wall, Okular village*



Figure 47: *One storey house, built with infill bricks, Aşağıkanathı village*



Figure 48: *Outside view of three storey house, infill bricks filled with concrete as load bearing walls, in Okular*

8.4 Masonry Houses with Refractory Bricks

- Refractory bricks have not been commonly used in that territory, except few examples. One of the examples is a mosque in Incedal village, built in 1982, shown below.



Figure 49: *Outside view of the mosque, Incedal village*



Figure 50: *Outside view of the mosque, Incedal village*



Figure 51: *Outside view of the mosque, Incedal village*



Figure 52: *Outside view of the mosque, Incedal village*



Figure 53: *Outside view of the mosque, Incedal village*



Figure 54: *Outside view of the mosque, Incedal village*



Figure 55: *Inside view of the mosque, Incedal village*



Figure 56: *Inside view of the mosque, Incedal village*

- Another building type, which is constructed with refractory bricks, is single story houses, constructed after 1971 Bingol earthquake. In higher altitude villages, these houses were constructed with refractory bricks and timber crosses, while in the lower altitude villages, material is prefabricated panels, having glass fibres inside for heating isolation. However, these small houses have not been renewed, so most of them have been being used as storage rooms. Although most of them seem heavily damaged depending on earthquakes over years, as well as lack of renovation, it is possible to see many of these houses standing after earthquake with partial collapses or without any collapse...



Figure 57: *Refractory brick houses built after 1971 Bingol earthquake, Okcular*



Figure 58: *Refractory brick houses built after 1971 Bingol earthquake, Okcular*



Figure 59: *Refractory brick houses built after 1971 Bingol earthquake, Okcular*



Figure 60: *Refractory brick houses built after 1971 Bingol earthquake, Yukarıkanatlı village*



Figure 61: Prefabricated panel houses built after 1971 Bingol earthquake, still in use, Incedal village



Figure 62: Prefabricated panel houses built after 1971 Bingol earthquake, being used as storage room, Incedal village

8.5 Reinforced Concrete Houses

- In the territory, there are few number of reinforced concrete houses built after 2003 Bingol earthquake. Some of these RC houses built by government, and some of them are with personal initiatives.



Figure 63: RC house, without any damage in beam-column joints, Okcular village



Figure 64: RC house, without any damage in beam-column joints, Okcular village



Figure 65: RC house, without any damage in beam-column joints, Okcular village

- Most of them are standing without any damage after earthquake. However, some minor damages are visible in few of these RC houses, such as the ones suffered from differential settlements in Incedal, which is a village constructed on saturated soft soil conditions.



Figure 66: RC house, built by government, after 2003 Bingol earthquake, Tabanözü village



Figure 67: RC house, built by government, after 2003 Bingol earthquake, Incedal village



Figure 68: RC house, built by government, after 2003 Bingol earthquake, Incedal village



Figure 69: RC house, built by government, after 2003 Bingol earthquake, Incedal village



Figure 70: RC house, built by government, after 2003 Bingol earthquake, Incedal village







Figure 71: *RC house, built by government, after 2003 Bingol earthquake, Incedal village*

9 Building Damage Types

Before mentioning about damage types, it could be better to classify damage patterns on masonry buildings. Below table summarizes European Macroseismic Scale damage classification for masonry buildings

Table 9: Classification of damage to masonry buildings in European Macroseismic Scale

| Classification of damage to masonry buildings | |
|---|--|
|  | <p>Grade 1: Negligible to slight damage (no structural damage, slight non-structural damage) Hair-line cracks in very few walls. Fall of small pieces of plaster only. Fall of loose stones from upper parts of buildings in very few cases.</p> |
|  | <p>Grade 2: Moderate damage (slight structural damage, moderate non-structural damage) Cracks in many walls. Fall of fairly large pieces of plaster. Partial collapse of chimneys.</p> |
|  | <p>Grade 3: Substantial to heavy damage (moderate structural damage, heavy non-structural damage) Large and extensive cracks in most walls. Roof tiles detach. Chimneys fracture at the roof line; failure of individual non-structural elements (partitions, gable walls).</p> |
|  | <p>Grade 4: Very heavy damage (heavy structural damage, very heavy non-structural damage) Serious failure of walls; partial structural failure of roofs and floors.</p> |
|  | <p>Grade 5: Destruction (very heavy structural damage) Total or near total collapse.</p> |

Different than the “Building Types” part of this report, no classification will be made while defining the damage types, since same deficiencies are effective in most of the buildings.

The main reason for damage in most of the buildings is “improper construction technique”; therefore below mentioned items are attributed to this main reason. Intention of having this observation is that, bad quality material is not the only reason for failure, but when it combines with improper construction technique, partial or total collapse is inevitable.

Although, it is not so convenient to separate reasons of failure mechanisms since one reason triggers another, damage patterns are tried to be classified in the below items.

- The most common damage type is partial collapse of load bearing walls due to “out of plane” behaviour.
 - One reason of this failure type is “incapable connections” between outer walls and outer walls with perpendicularly connected inside walls.



Figure 72: Only vertical lintel application ever seen, Beyhani-Palu



Figure 73: Out of plane failure in one story, stone school building (being used for storage), Gocmezler village

- Length of walls is another parameter, causing out of plane behaviour. In other words, longer the wall length is, easier the out of plane failure occurs.



Figure 74: *Out of plane failure due to length of wall in two story stone house, Okcular village*

- Also, using different material for outer and inner walls, such as soil bricks for inner walls and stones for outer walls, decreases the integrity among the walls due to incompatible element (stone vs. brick) dimensions as well as different dynamic behaviour of the stone or brick walls.



Figure 75: *Out of plane failure due to lack of integrity between soil brick and stone walls in one story house, Aşağıkanatlı village*

- Another reason, triggering out of plane behaviour is the lack of rigid diaphragm effect of slabs at floor levels, and deficiency of roof-wall connections, no matter it is a truss-roof system or composed with timbers. Usually slabs are constructed as rigid in one direction, so they are not capable of “holding” the walls together and transmit the lateral forces. Also, in timber roofs, there is soil layer in most of the houses, having a thickness about 25 cm, which increases the weight at roof level.



Figure 76: *Out of plane failure in two story stone houses, Okcular village, in both pictures “lack” of rigid diaphragm effect is visible, as well as bad integrity of walls constructed with different materials.*



Figure 77: *Out of plane failure in one story stone house, Yukarıkanath village*



Figure 78: *Thick soil layer on the roof, Kayalık village*

- Insufficient “interlock” among the rounded, heavy stones in outer walls, or between the smaller rounded ones, used inside the double layered outer walls.



Figure 79: *Insufficient interlock among the rounded stones, Okçular village*

- Even if load bearing walls could stand after earthquake without total or partial collapse, wide cracks prevents usability of the buildings.
 - Bad quality of mortar is one of the reasons for wide cracks.



Figure 80: *Wide cracks following the mortar, Yukarıdemirci village*



Figure 81: *Wide cracks following the mortar, school building side view, Kayalık village*



Figure 82: *Wide cracks following the mortar, Okcular village*

- Thin, wooden, horizontal lintels would not be sufficient to strengthen the weak corners of the openings. Also, in some cases, they were so widely spaced.



Figure 83: *Wide cracks around openings, Beyhan-Palu*

- In most of the stone walls, stones were not properly arranged.



Figure 84: *Improperly arranged stone walls, İncedal village*



Figure 85: *Single example of properly arranged, layered, triangular shaped, one story house, inside walls are soil bricks, Tabanözü village*

- Soft story mechanisms, due to lower ground floor height. Actually, this irregularity type can easily cause total collapse as it is the case in higher altitude villages. However, the picture below belongs to İncedal, which is located at the bottom lowland.



Figure 86: *Lower ground floor, being used as a stall, İncedal village*

- In the following nine figures, damage patterns on walls of a two storey sun-dried soil brick house are shown. Heavy damage is not so obvious from outside, however, inside pictures show the inconvenience for usage.



Figure 87: Outside view of two storey soil brick house in Kökan-Bayramyazı-1



Figure 88: Inside view of two storey soil brick house in Kökan-Bayramyazı-2



Figure 89: *Inside view of two storey soil brick house in Kökan-Bayramyazı-3*

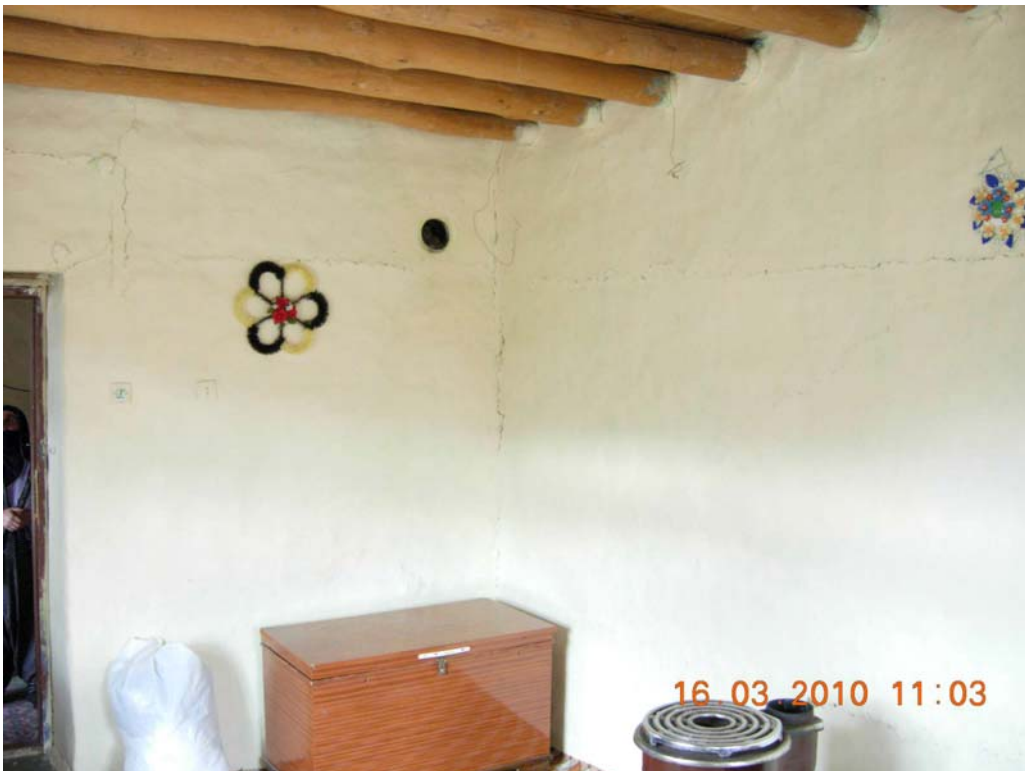

Figure 90: *Inside view of two storey soil brick house in Kökan-Bayramyazı-4*



Figure 91: *Inside view of two storey soil brick house in Kökan-Bayramyazı-5*



Figure 92: *Inside view of two storey soil brick house in Kökan-Bayramyazı-6*



Figure 93: *Inside view of two storey soil brick house in Kökan-Bayramyazi-7*



Figure 94: *Inside view of two storey soil brick house in Kökan-Bayramyazi-8*



Figure 95: *Inside view of two storey soil brick house in Kökan-Bayramyazı-9*

10 Results and Recommendations

March 8, 2010 Başıyurt-Karakoçan earthquake shows that strike slip faulting continues being effective in that region. Once faulting characteristics of the region is considered, Başıyurt-Karakoçan earthquake occurred depending on the rupture in NE-SW direction of Bingöl-Palu part of East Anatolian Fault Zone. Cumulative distribution area of aftershocks is about 31 km.

During the site investigations, fault cracks could not be observed. However, deformations, settlements, some landslides and liquefaction cases have been watched over. Based on the relationship between surface waves and fault length, fault length can be determined as follows;

$$\begin{aligned} \text{Log } L &= 0.58 \times M_s - 2.19 \text{ (Ezen, 1981)} \\ M_s &= 1.72 \times \log_{10}(L) + 3.7775 \\ \text{For } M_s &= 5.9, \quad L \approx 17 \text{ km.} \end{aligned}$$

Intensity can be determined via magnitude-intensity relationship. Below determined intensity ($I_0=VII$) is compatible with the one observed during site investigations.

$$\begin{aligned} I_0 &= 1.69 M - 2.76 \text{ (Ipek et.al.; 1965)} \\ \text{For } M &= 6.0, \quad I_0 = VII. \end{aligned}$$

Also distribution of aftershocks supports the above determined fault length of 17 km. This distribution is in direction of N-NE, and most them are shallow earthquakes. Obtained information shows that released energy spread dominantly in NNE-SSW and NE-SW directions. Probably, Başıyurt-Karakoçan earthquake will trigger the adjacent smaller fault parts or other fault zones in near future, especially faults within Erzincan-Bingöl-Tunceli Elazığ region. The risk of earthquake occurrence in this region is high; therefore earthquakes with similar magnitudes due to this stress summation shall be taken into account. Fault mechanism analyses show that, biggest stress axes are generally in the direction of N-NW and S-SE for P-compression, and E-NE and W-SW for T dilatation.

Main reasons of dense damage within Başıyurt-Kovancılar-Gökdere region are as following;

- Improper material and construction techniques have been used.
- Villages are located on steep and risky locations for landslides or on flat but saturated soil conditions.

Generally, heavily damaged houses are the ones which do not have sufficient foundation systems, built with local poor construction materials and inconvenient constructions techniques. In this kind of high seismicity regions, buildings shall be constructed based on provisions of Turkish Seismic Code 2007, preferably as reinforced concrete. Even if masonry structures would be preferred, there must not be any concessions from seismic code requirements.

Acknowledgements

Thanks to Boğaziçi University Kandilli Observatory and Earthquake Research Institute Director Prof. Dr. Mustafa ERDIK for his support and contribution on preparation of this report and to Prime Minister Recep Tayyip ERDOĞAN, Elazığ Governor Muammer EROL, Sivrice District Governor Suat YILDIZ for their logistic support and cooperation.

References

Eyidoğan; H., U. Güçlü; Z. Utku, E. Değirmenci (1991). Türkiye büyük Depremleri Makro-sismik Rehberi (1900-1988), İTÜ MF Jeofizik Müh. Bölümü Yayınları s.200.

Ezen, Ü. (1981). Kuzuy Anadolu Fay Zonunda Deprem-Kaynak parametrelerinin manyitüdle ilişkisi, Deprem Araştırma Bülteni, Vol. 32, p. 53-77.

ELER, Earthquake Loss Estimation Routine, Technical and User Manuals V2.0, Bogazici University, KOERI, Earthquake Engineering Department, 2010

Grunthal, G. (editor) (1998). European macroseismic scale 1998. Cahiers du Centre Europeen de Geodynamique et de Seismologie. Conseil de l'Europe. Luxembourg, 1998.

Samardjieva, E. and J. Badal, 2002. Estimation of the expected number of casualties caused by strong earthquakes. Bulletin of the Seismological Society of America, 92 (6), pp. 2310-2322, Aug 2002

İpek, M. Z. Uz ve U. Güçlü (1965). Sismolojik donelere göre Türkiye'de deprem bölgeleri, Ankara.

Soysal, H., S. Sipahioğlu, D. Kolçak, Y. Altınok (1981). Türkiye ve Çevresinin Tarihsel Deprem Kataloğu, TÜBİTAK Proje No: TBAK 341, 87s., İstanbul.

Elazığ Valiliği web site.

MTA Genel Müdürlüğü web site 1.500 000 scale geological map